

PRODUCT SPECIFICATIONS

SwirlFlo® Bi-Level Reverse Fountain Mechanical Bubbler Non-Filtered Non-Refrigerated Stainless. Furnished with Flexi-Guard® Safety Bubbler. Mechanical Front Bubbler Button activation. Product shall be Wall Mount (On Wall), for Indoor + Outdoor applications, serving 2 station(s).

Finish:	Stainless Steel
Power:	No Electrical Required
Bubbler Style:	Flexi-Guard® Safety Bubbler
Activation by:	Mechanical Front Bubbler Button
Mounting Type:	Wall Mount (On Wall)
Chilling Capacity:	Non-refrigerated
Dimensions (L x W x H):	38-1/2" x 19" x 21-15/16"
Approx. Shipping Weight:	56 lbs.
Installation Location:	Indoor + Outdoor
No. of Stations Served:	2
**When used in non-temperature controlled environments, unit(s) must be adequately winterized and/or protected from extreme heat to prevent damage where climates dictate.	

Special Note: Requires In-Wall Carrier MPW200 (sold separately)

- Mechanically-Activated unit continues to supply water in event of service disruptions.



Included with Product: Fountain with Back Plate,

Ships in one box.

A Century of Tradition and Quality. For more than 100 years, Elkay has been making innovative products and providing exceptional customer care. We take pride in offering plumbing products that make life easier, inspire change and leave the world a better place.



PRODUCT COMPLIANCE

- ADA & ICC A117.1
- ASME A112.19.3/CSA B45.4
- NSF/ANSI 61 (Q≤1) & 372 (lead free)
- NSF REG4



Complies with ADA & ICC A117.1 accessibility requirements when installed according to the requirements outlined in these standards. Installation may require additional components and/or construction features to be fully compliant. Consult the local Authority Having Jurisdiction if necessary.

[Installation Instructions \(PDF\) - 97922C](#)

Water Systems are warranted for 12 months from date of installation. **Warranty pertains to drinking water applications only. Non-drinking water applications are not covered under warranty.**

[Warranty \(PDF\)](#)

PART: _____ QTY: _____

PROJECT: _____





CONTACT: _____

DATE: _____

NOTES: _____

APPROVAL: _____

In keeping with our policy of continuing product improvement, Elkay reserves the right to change product specifications without notice. Please visit elkay.com for the most current version of Elkay product specification sheets. This specification describes an Elkay product with design, quality, and functional benefits to the user. When making a comparison of other producers' offerings, be certain these features are not overlooked.

Optional Accessories		
EWF172	Universal Filtration Kit (1500-Gallon) Spec Sheet (PDF)	
MPW200	In-wall Mounting Plate for Bi-level On-wall Non-refrigerated Fountains Spec Sheet (PDF)	
ACCESS12X38-5	Stainless Steel Access Panel for Bi-Level Architectural Fountains Spec Sheet (PDF)	
LKAPR1	Cane Apron for SwirlFlo® Gray Spec Sheet (PDF)	

In keeping with our policy of continuing product improvement, Elkay reserves the right to change product specifications without notice. Please visit elkay.com for the most current version of Elkay product specification sheets. This specification describes an Elkay product with design, quality, and functional benefits to the user. When making a comparison of other producers' offerings, be certain these features are not overlooked.

INSTALLER NOTE

This drinking fountain is furnished with a bubbler and valve including all connecting fittings which are manufactured of completely lead free material. Shut off valve (not furnished) to accept 3/8" O.D. unplated copper tube.

These products are designed to operate on 20 psi to 105 psi supply line pressure. Simultaneous operation of both bubblers on a bi-level unit may not be possible depending on water supply pressure. If simultaneous operation is desired, please ensure a minimum of 50 psi supply.

OPERATION OF QUICK CONNECT FITTINGS

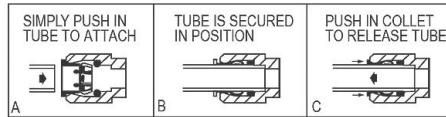

PUSHING TUBE IN BEFORE PULLING IT OUT HELPS TO RELEASE TUBE

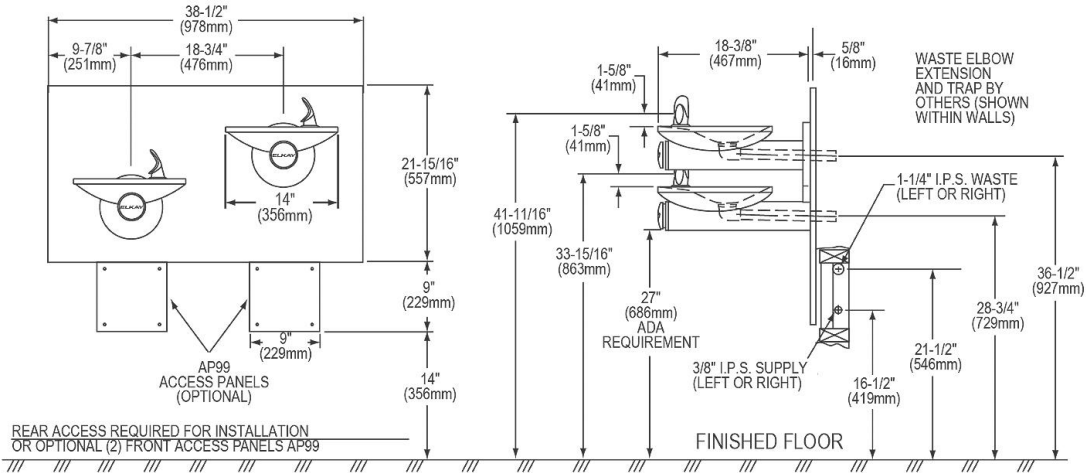
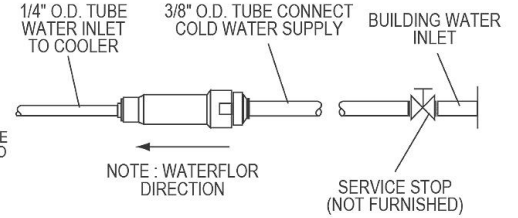

In keeping with our policy of continuing product improvement, Elkay reserves the right to change product specifications without notice. Please visit elkay.com for the most current version of Elkay product specification sheets. This specification describes an Elkay product with design, quality, and functional benefits to the user. When making a comparison of other producers' offerings, be certain these features are not overlooked.