

PRODUCT SPECIFICATIONS

Remote type, electric refrigerated water chiller unit. Chilling Capacity of 8.0 GPH (gallons per hour) of 50° F drinking water, based on 80° F inlet water and 90° F ambient, per ASHRAE 18 testing. Installs directly under fountain or other application, or may be located in service area to serve up to 2 remote outlets (within 15 feet recommended). Unit shall be certified to UL 399 and CAN/CSA C22.2 No. 120.

Compact, highly efficient water chiller units are designed for use where large quantities of chilled water are required.

Finish:	Galvanized Steel
Power:	115V/60Hz
Chilling Capacity*:	8.0 GPH
Full Load Amps	5
Rated Watts:	370
Dimensions:	13-1/4" x 10-1/4" x 17-3/8"
Approx. Shipping Weight:	43 lbs.
Installation Location:	Indoor
No. of Stations Served:	2
*Based on 80° F inlet water & 90° F ambient air temp for 50° F chilled drinking water.	

CONSTRUCTION

- Cabinet: Rust-resistant galvanized steel

COOLING SYSTEM

- Compressor: Hermetically-sealed, reciprocating type, single phase. Sealed-in lifetime lubrication.
- Condenser: Fan cooled, copper tube with aluminum fins. Fan motor is permanently lubricated.
- Cooling Unit: Combination tube-tank type. Continuous copper tubing is fully insulated with foam that meets UL requirements for self-extinguishing material.
- Refrigerant Control: Refrigerant R-134a is controlled by accurately calibrated capillary tube.
- Temperature Control: Easily accessible enclosed adjustable thermostat is factory preset. Requires no adjustment other than for altitude requirements.



A Century of Tradition and Quality. For more than 100 years, Elkay has been making innovative products and providing exceptional customer care. We take pride in offering plumbing products that make life easier, inspire change and leave the world a better place.



Included with Product: Water Chiller

PRODUCT COMPLIANCE

CAN/CSA C22.2 No. 120

NSF/ANSI 61 (Q₁) & 372 (lead free)

UL 399



[Installation Instructions \(PDF\) - 200000694](#)

[Warranty \(PDF\)](#)

PART: _____ QTY: _____

PROJECT: _____



CONTACT: _____

DATE: _____

NOTES: _____

APPROVAL: _____

In keeping with our policy of continuing product improvement, Elkay reserves the right to change product specifications without notice. Please visit elkay.com for the most current version of Elkay product specification sheets. This specification describes an Elkay product with design, quality, and functional benefits to the user. When making a comparison of other producers' offerings, be certain these features are not overlooked.

Optional Accessories		
732710751550	On-wall Chiller Shelf for Use With 8 GPH Chillers Spec Sheet (PDF)	
PM4	On-wall Chiller Shelf for Use With 8 or 19 GPH Chillers Spec Sheet (PDF)	
734261251550	In-wall Chiller Box for Use With 1 or 8 GPH Chillers Spec Sheet (PDF)	

In keeping with our policy of continuing product improvement, Elkay reserves the right to change product specifications without notice. Please visit elkay.com for the most current version of Elkay product specification sheets. This specification describes an Elkay product with design, quality, and functional benefits to the user. When making a comparison of other producers' offerings, be certain these features are not overlooked.

Operating Pressures:

Supply water - recommended water pressure range is 40-105 psi

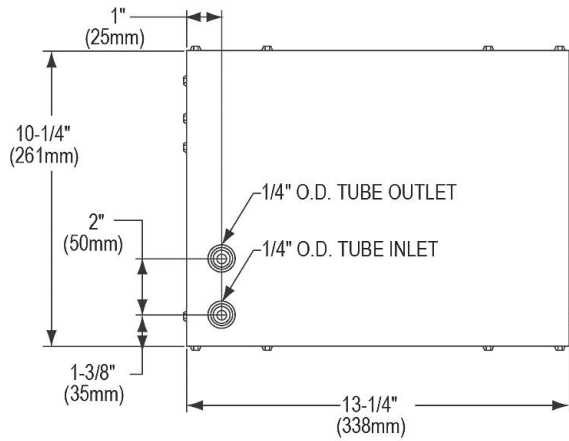

TOP VIEW

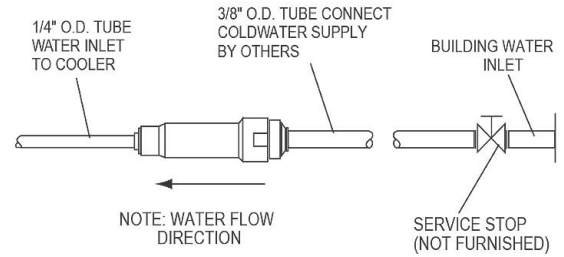

OPERATION OF QUICK CONNECT FITTINGS

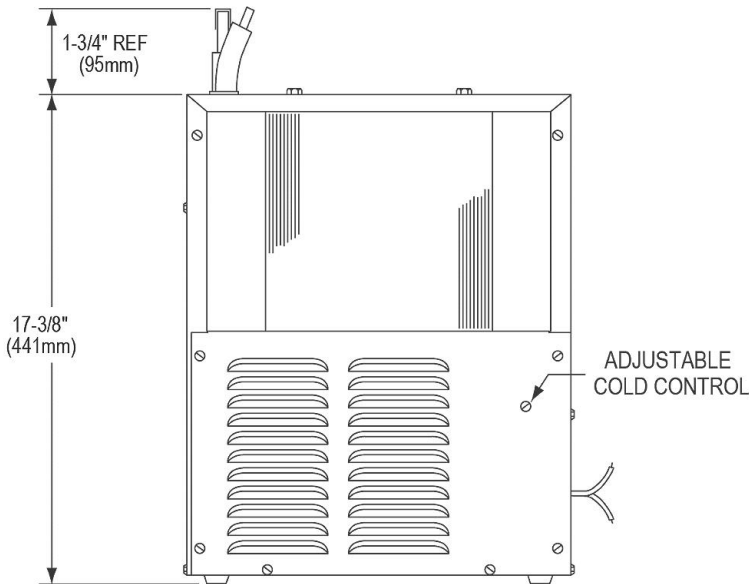
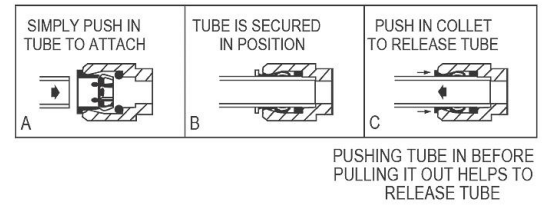

FRONT VIEW

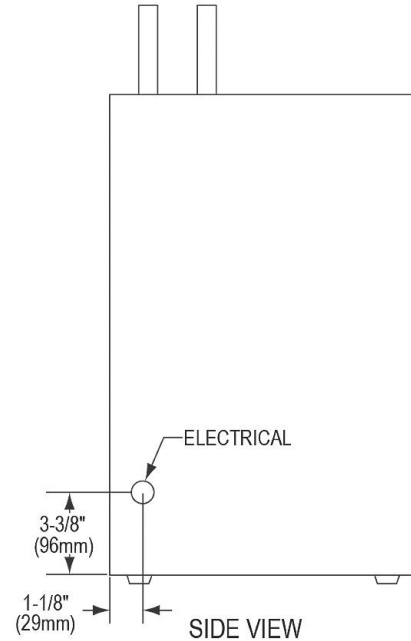

SIDE VIEW

NOTE: When mounting unit in an open area, to ensure proper ventilation, maintain a 4" (102mm) clearance from cabinet louvers on each side of chiller. When mounting unit in a cavity or behind a wall, maintain minimum space of 4" (102mm) on each side, 4" (102mm) on the top and a depth of 12" (305mm).

In keeping with our policy of continuing product improvement, Elkay reserves the right to change product specifications without notice. Please visit elkay.com for the most current version of Elkay product specification sheets. This specification describes an Elkay product with design, quality, and functional benefits to the user. When making a comparison of other producers' offerings, be certain these features are not overlooked.